

TV252150C

Caleffi 252 20mm Solar Tempering Valve with Hot & Cold Check Valve



Technical Specification

- Temp Adjustment Range 30 - 65°C
- Temp Control +/- 2°C
- Max Op. Temp. 100°C
- Operating Press. Range 20 - 500kpa
- Max. Inlet Press. Ratio 2:1
- Max Test Press. 1400kPa
- Min. flow rate 5L/min
- Material DZR Brass

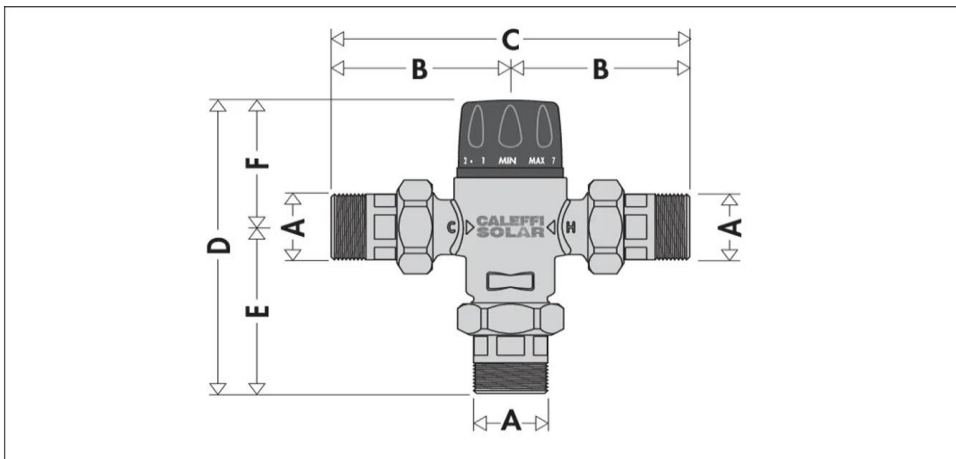

Code	DN	A	B	C	D	E	F	Mass (kg)
252150	20	3/4"	78,5	157	169	95,5	73,5	1,35
252160	25	1"	104,5	209	195,5	109	86,5	2,50
252170	32	1 1/4"	104,5	209	195,5	109	86,5	2,47
252180	40	1 1/2"	121	242	219,5	129	90,5	3,81
252190	50	2"	131	262	234,5	139	95,5	5,58

Warranty

[Download the latest warranty statement](#)

Features

- Solar 2521 series tempering valve with 20mm unions
- For use on high temperature domestic hot water systems for a flow rate of up to 35L/min
- Union connectors with o-ring seal with hot and cold check valves